

# CLASSIC WHEELCHAIR TIE-DOWNS

User Manual

Applicable to products

I-RQE10MK, I-RQ10MT, I-RQ10PT, I-RQE10MH, I-RQ10PJ,  
I-RQ10MJ, I-RQE10PJ, I-RQE10MJ, I-SQE10PK, I-SQ10MJ,  
I-SQE10PJ, I-SQE10MJ

K-RQE10MK, K-RQ10MT, K-RQ10PH, K-RQE10MH,  
K-RQ10PJ, K-RQ10MJ, K-RQE10MJ, K-SQE10PK,  
K-SQ10PJ, K-SQ10MJ, K-SQE10PJ, K-SQE10PJ

U112356

EN Instructions for fitting and use

Thank you for choosing

# Classic wheelchair tie-downs from BraunAbility!

The following manual is an important part of the product, providing you with information on how to achieve maximum performance and safe operation. Keep the manual in a safe place so you can refer to it when necessary.

If you have any questions about your equipment, please contact us.

Once again, thank you for placing your confidence in our products!



Safe vehicle adaptation solutions

*For your safety BraunAbility products are designed and tested according to current directives and standards.*

## Safety information

---

- 4 Limitation of use
- 6 General guidance
- 8 Before installing and the compact wheelchair tie-downs

## Fit and use

---

- 10 Fit and use - tie-down with reversible stalk - rail floor
- 12 Fit and use - tie-down with reversible stalk - Solo anchor
- 14 Fit and use - tie-down with fixed stalk - rail floor
- 16 Fit and use - tie-down with fixed stalk - Solo anchor

## After care

---

- 18 Equipment storage and maintenance
- 19 Warranty

”Declaration of conformity” at the end of the manual.

## Safety information

### Limitation of use

The development of BraunAbility kits is a continuous process. Applications are added on a regular basis. For more details contact BraunAbility or look on the BraunAbility website.



*These BraunAbility wheelchair tie-down kits are designed to secure a wheelchair when facing forward in a vehicle and must be used as instructed.*



*In addition to the details given in these instructions, users of BraunAbility wheelchair tie-down kits must refer to the wheelchair manufacturer's 'Instructions for Use in Transport' for full details of tie-down attachment points on the wheelchair, plus any other specific instructions relating to use in transport.*



*Wheelchair users and their carers must make sure that their wheelchair is recommended for use in transport, including any 'add-on' components such as power tilt or recline options.*



*BraunAbility recommends the use of a 3 point occupant restraint system to provide greater protection in case of an impact. However, we also recognise that some vehicle layout/designs or specific postural or medical conditions do not allow that style of seatbelts to be used easily.*

*This system is not ISO 10542 compliant if used in a 2 point configuration.*



*In accordance with international regulations, our occupant restrains are designed to be used for passengers weighing 22kg or above. If the passenger weighs less than 22kg, we recommend that a suitable, and appropriately tested child restraint seat is used. This may involve a secondary seat belt restraint as recommended by the original seat manufacturer.*



I-RQ10MT



I-SQE10PJ



K-RQE10MK



K-SQ10PJ

### General guidance

- Wheelchair Accessories that have not been approved by the Wheelchair Manufacturer must be removed from the wheelchair and secured in the vehicle during transport to reduce the potential for injury. Refer to 'Instructions For Use in Transport' provided with the wheelchair or contact wheelchair manufacturer for further guidance.
- These wheelchair tie-downs comply with all applicable requirements of ISO 10542, including a 48km/h, 20g frontal impact test using a forward facing surrogate 85kg wheelchair and an ATD (test dummy) with a mass of 76.3kg. The test dummy was restrained by both a pelvic and upper-torso restraint. Use of a pelvic only belt may compromise the performance of the wheelchair tie-down and occupant restraint system (WTORS) and should be avoided.
- If the installation is to be used with an occupant headrest anchored to the vehicle, then a vehicle-anchored back rest must be provided to minimise rearward deflection of the wheelchair seatback, preventing neck injury.
- Regular inspection of all parts is recommended and the equipment should be used only if all components are in good condition.
- **Warning:** protect webbing from contacting sharp edges and corners. Replace equipment if the webbing becomes cut, frayed, or contaminated with polishes, oils or chemicals, particularly battery acid.

- Any restraints which have been subjected to a crash situation from which the vehicle must be towed, should, in the interest of safety, be replaced.
- Do not attempt to modify the equipment. For further advice on the installation and use of this wheelchair tie-down, please contact BraunAbility. Please read this manual fully before use.
- Avoid contact with corrosive liquids. Care should be taken to prevent contamination of the webbing with polishes, oils and chemicals.
- The wheelchair tie-down anchorages should be installed by an experienced technician/vehicle converter. Anchorages should not be installed into unsound materials such as corroded metal, wood, plastic and fibreglass panels, without additional and suitable reinforcement.
- The equipment has been tested in a configuration recommended by BraunAbility and any deviation from the recommendations here is the responsibility of the installer/user.

## Before installing the classic retractable tie-downs

- Ensure that the wheelchair is correctly maintained and that the settings of any adjustable parts are made according to 'Instructions for Use in Transport'.
- Whenever possible remove any items of luggage etc that may be attached to the wheelchair and secure or store separately during transport in order to reduce the potential for injury to other passengers traveling in the vehicle.
- Position the wheelchair facing forward - centrally in the designated region of the vehicle.  
**Ensure the wheelchair brakes are applied.**
- To minimize the potential for head injuries in an impact, allow a clear space of at least 450mm (18in) behind and 650mm (26in), (FCZ, front clear zone), in front of the head of the wheelchair user, (Fig A). The shoulder belt anchorage must be roof or side-wall anchored at a height level such that the belt webbing passes over the midpoint of the occupant shoulder and at a height that is at or just above the level of the occupants shoulders so as not to impose downward loads on the spine.
- A height provision (HHT) ranging from 1000mm (39in) to 1550mm (61in) should be made, depending on the size of the passenger. There should also be 200mm (8in) of clear space either side of the wheelchair center line. If these clear space dimensions cannot be provided then any structure protruding into this area should be adequately padded and comply with impact performance requirements of ECE Regulation 21 'FMVSS 201'. All vehicle padding should comply with the flammability requirements of ECE Regulation 118 'FMVSS 302'.

*Note: seated head height (HHT) ranges from as low as 1000mm (39in) for a 6-year-old child to 1550mm (61in) for a tall adult.*



- Wheelchair users, their caregivers and family are advised to check vehicle specifications to ensure that sufficient floor space is available to accommodate the wheelchair and tie-down system. These distances are based upon the desire to maintain clear zones for potential head excursions of occupants provided with both upper and lower torso restraints.
- Users of heavy powered wheelchairs are also advised to check vehicle carrying capacity. If in doubt consult the vehicle supplier for further details.
- Any airbag, as fitted to the vehicle, shall be used only as a supplementary occupant restraint if designed to be used in combination with the WTORS.
- Installers of this tie-down should take note of any vehicle airbag position when planning the installation. Airbags can cause serious injury if a wheelchair-seated occupant is seated too close to an airbag position. If in doubt contact the vehicle manufacturer or your National Automotive Regulatory Body for advice.

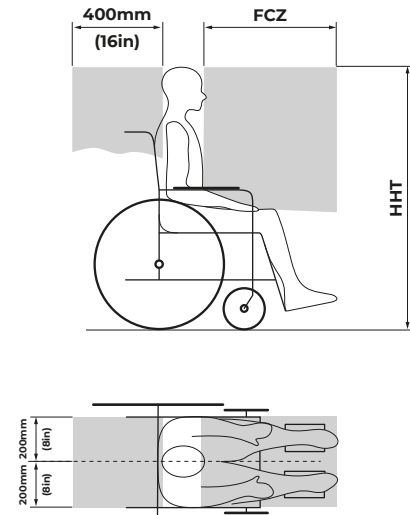
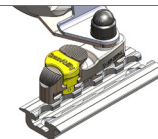

Figure A

## Fit and use

### Classic retractable tie-downs

#### Rail floor - reversible stalk (I- products) - rear



1. The rail will have been installed in the vehicle in accordance with our own and the vehicle converter's instruction. Position the wheelchair within the vehicle as required.
2. Attach the front wheelchair tie-down (not supplied as part of this product) in accordance with its own instruction.
3. Place the rear retractable restraint into the rail behind the wheelchair. If using tongue & buckle attachments, or J-hooks, the retractors are suitable for either left or right hand use. For retractors with karabiners or hooks, ensure that the open gate of the karabiners or hooks are facing outboard from the wheelchair, (Fig. 1A). The reversible stalk should be rotated so that the red buckle button is facing outboard from the wheelchair.
4. Attach each tie-down into the rail floor by aligning the ATF (aluminium track fitting) feet with the cut-out sections of the rail, (Fig. 2). **Note:** the yellow plungers must face toward the rear of the vehicle. Press down on the ribbed part of the ATF, (Fig. 2A) and push firmly down towards the wheelchair until the yellow plunger drops and locks into the rail.

**IMPORTANT: Ensure that the plungers are fully engaged on both sides.**

5. Dependent on retractor type, follow instruction:
 

**Quattro:** Press the release button(s), (Fig. 1B), to release the webbing and attach each of the karabiner, hook or tongue and buckle arrangements to the wheelchair's rear frame. (Some wheelchairs will indicate this position, Fig. 3). Press the yellow button(s) again to remove the webbing slack.

**Quattro Express:** Webbing can be extended from the reel without pressing the yellow button if the lock label, (Fig. 1D), is NOT visible. Attach each of the wheelchair attachments to the wheelchair's rear frame. (Some wheelchairs will indicate this position, Fig. 3). The yellow button must be pressed if extending webbing with the label in view, (Fig. 1C). The webbing will retract automatically into the reel. **IMPORTANT: The yellow locking label must be fully visible to ensure that the reel is locked off, (Fig. 1D).**
6. Final tensioning is achieved by turning each tensioning handle, (Fig. 1C) until the webbing is equally taut on each side. Ensure that each rear tie-down webbing is approximately of the same length and that an angle of around 30° to 45° has been created, within the rear view zone, (Fig. 4).
7. An occupant restraint must now be fitted. Please refer to relevant manual.

#### Removing the combined retractable tie-downs

##### **IMPORTANT: First remove the occupant restraint.**

1. Release the tension in the rears by pressing the yellow button, (Fig. 1C) and extend the webbing to allow the tongue and buckles, hooks or karabiners to be removed from the wheelchair frame. If the webbing is particularly tight, it may be necessary to slightly 'tension' with the hand wheel, (Fig. 1B) in order to remove the webbing lock on the Quattro.
2. Lift the yellow plunger fully, slide back away from the wheelchair to align the ATF feet with the rail cut outs, lift away from the rail.
3. Repeat operation with the opposite tie-down and store safely.

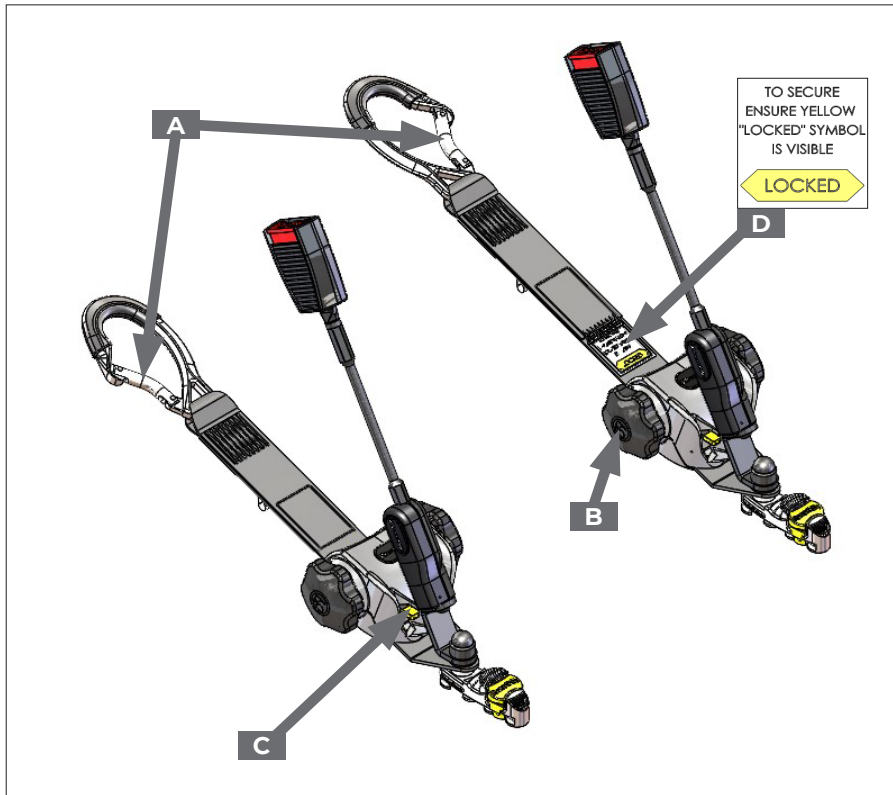

Figure 1

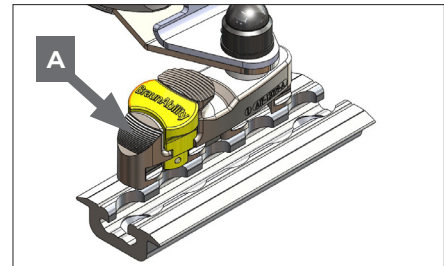

Figure 2

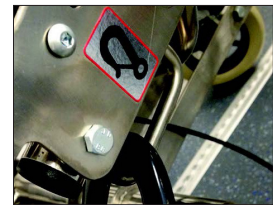
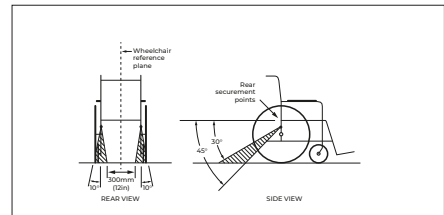

Figure 3



**NOTE** Note that angles indicated are obtained by projecting the angle of each tie-down strap onto a vertical plane parallel to the wheelchair reference plane (side view) or onto a vertical plane that is perpendicular to the wheelchair reference plane (rear view).

Figure 4

## Fit and use

### Classic retractable tie-downs

#### Solo anchor - reversible stalk (I- products) - rear

1. The Solo floor anchors will have been installed in the vehicle in accordance with their own and the vehicle converter's instruction. Position the wheelchair within the vehicle as required.
2. Install each front retractor cleat onto a front Solo anchor by aligning the open mouth of the cleat and the protrusion, (Fig. 6C), to the slot on the floor anchor. Slide the cleat fully home (allowing the keyway within the cleat to guide into its home position, Fig. 6A & B) and rotate the cleat through 90° to align the retractor with the wheelchair frame, (Fig. 7).
3. Dependent on retractor type, follow instruction:  
**Quattro:** Press the release button(s), (Fig. 5B), to release the webbing and attach each J-hook arrangements to the wheelchair's rear frame, with the open gate facing outboard. (Some wheelchairs will indicate this position, Fig. 3). Press the yellow button(s) again to remove the webbing slack.  
**Quattro Express:** Webbing can be extended from the reel without pressing the yellow button if the lock label, (Fig. 5D), is NOT visible. Attach each of the wheelchair attachments to the wheelchair's rear frame. (Some wheelchairs will indicate this position, Fig. 3). The yellow button must be pressed if extending webbing with the label in view, (Fig. 5B). The webbing will retract automatically into the reel. **IMPORTANT: The yellow locking label must be fully visible to ensure that the reel is locked off, (Fig. 5D).**
4. Final tensioning is achieved by turning each tensioning handle, (Fig. 5B), until the webbing is equally taut on each side.
5. Ensure that the webbing of each tie-down is approximately the same length, and at an angle of around 30 to 45°, within the rear view zone, (Fig. 8).
6. The occupant restraint must now be fitted. Please refer to relevant manual.

#### Removing the combined retractable tie-downs

#### **IMPORTANT: First remove the occupant restraint.**

1. Release the tension in the front tie-downs by pressing the yellow button, (Fig. 5B), and extending the webbing to allow the J-hook, (Fig. 5A), to be removed from the wheelchair frame. If the webbing is particularly tight, it may be necessary to slightly 'tension' the webbing with the hand wheel, (Fig 5C), while pressing the yellow button, (Fig. 5B), to remove the webbing lock on the retractor.
2. Remove each front retractor from the anchor by rotating the tie-down through 90° so that the raised protrusion, (Fig. 6C), on the cleat is facing its parallel cleat.
3. Pull the tie-down away from the floor anchor and store safely.



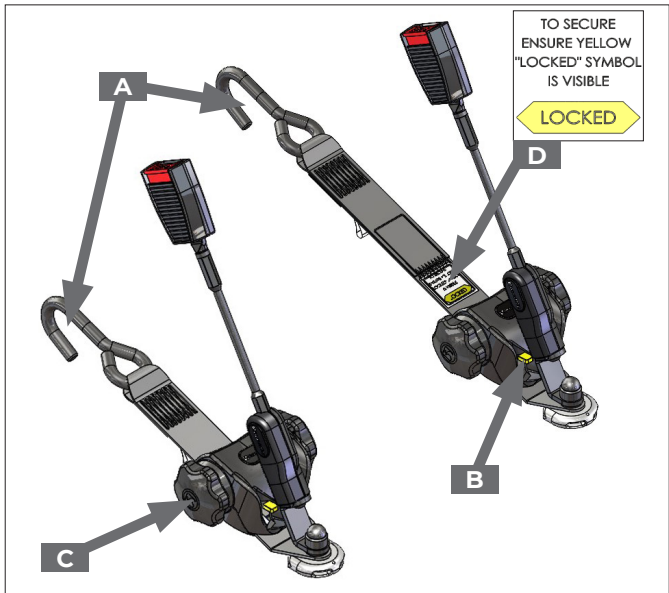

Figure 5

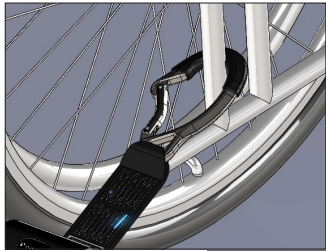

Figure 4

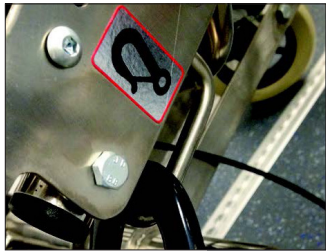

Figure 3

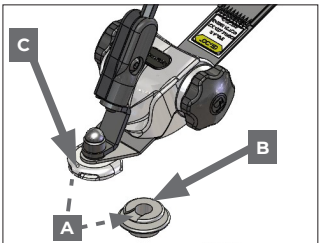

Figure 6

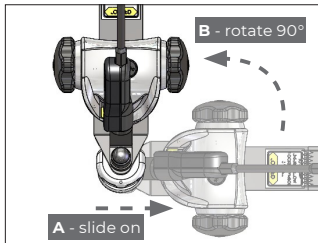
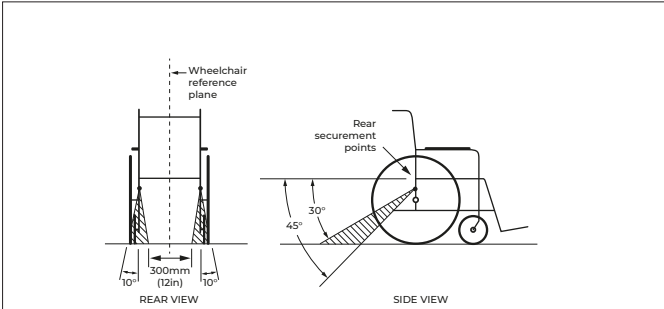

Figure 7



**NOTE** Note that angles indicated are obtained by projecting the angle of each tie-down strap onto a vertical plane parallel to the wheelchair reference plane (side view) or onto a vertical plane that is perpendicular to the wheelchair reference plane (rear view).

Figure 8

## Fit and use

### Classic retractable tie-downs

#### Rail floor - fixed stalk (K- products) - rear

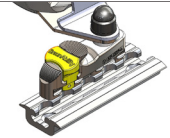

1. The rail will have been installed in the vehicle in accordance with our own and the vehicle converter's instruction. Position the wheelchair within the vehicle as required.
2. Attach the front wheelchair tie-down (not supplied as part of this product) in accordance with its own instruction.
3. Place the rear retractable restraint into the rail behind the wheelchair. If using tongue & buckle attachments, or J-hooks, the retractors are suitable for either left or right hand use. For retractors with karabiners or hooks, ensure that the open gate of the karabiners or hooks are facing outboard from the wheelchair, (Fig. 9A). The red buttons on the fixed stalks on both retractors should be facing outboard from the wheelchair.
4. Attach each tie-down into the rail floor by aligning the ATF (aluminium track fitting) feet with the cut-out sections of the rail, (Fig. 2). **Note:** the yellow plungers must face toward the rear of the vehicle. Press down on the ribbed part of the ATF, (Fig. 2A) and push firmly down towards the wheelchair until the yellow plunger drops and locks into the rail.

**IMPORTANT: Ensure that the plungers are fully engaged on both sides.**

5. Dependent on retractor type, follow instruction:
 

**Quattro:** Press the release button(s), (Fig. 9B), to release the webbing and attach each of the karabiner, hook or tongue and buckle arrangements to the wheelchair's rear frame. (Some wheelchairs will indicate this position, Fig. 3). Press the yellow button(s) again to remove the webbing slack.

**Quattro Express:** Webbing can be extended from the reel without pressing the yellow button if the lock label, (Fig. 9D), is NOT visible. Attach each of the wheelchair attachments to the wheelchair's rear frame. (Some wheelchairs will indicate this position, Fig. 3). The yellow button must be pressed if extending webbing with the label in view, (Fig. 9C). The webbing will retract automatically into the reel. **IMPORTANT: The yellow locking label must be fully visible to ensure that the reel is locked off, (Fig. 9D).**
6. Final tensioning is achieved by turning each tensioning handle, (Fig. 9C) until the webbing is equally taut on each side. Ensure that each rear tie-down webbing is approximately of the same length and that an angle of around 30° to 45° has been created, within the rear view zone, (Fig. 4).
7. An occupant restraint must now be fitted. Please refer to relevant manual.

#### Removing the combined retractable tie-downs

##### **IMPORTANT: First remove the occupant restraint.**

1. Release the tension in the rears by pressing the yellow button, (Fig. 9C) and extend the webbing to allow the tongue and buckles, hooks or karabiners to be removed from the wheelchair frame. If the webbing is particularly tight, it may be necessary to slightly 'tension' with the hand wheel, (Fig. 9B) in order to remove the webbing lock on the Quattro.
2. Lift the yellow plunger fully, slide back away from the wheelchair to align the ATF feet with the rail cut outs, lift away from the rail.
3. Repeat operation with the opposite tie-down and store safely.

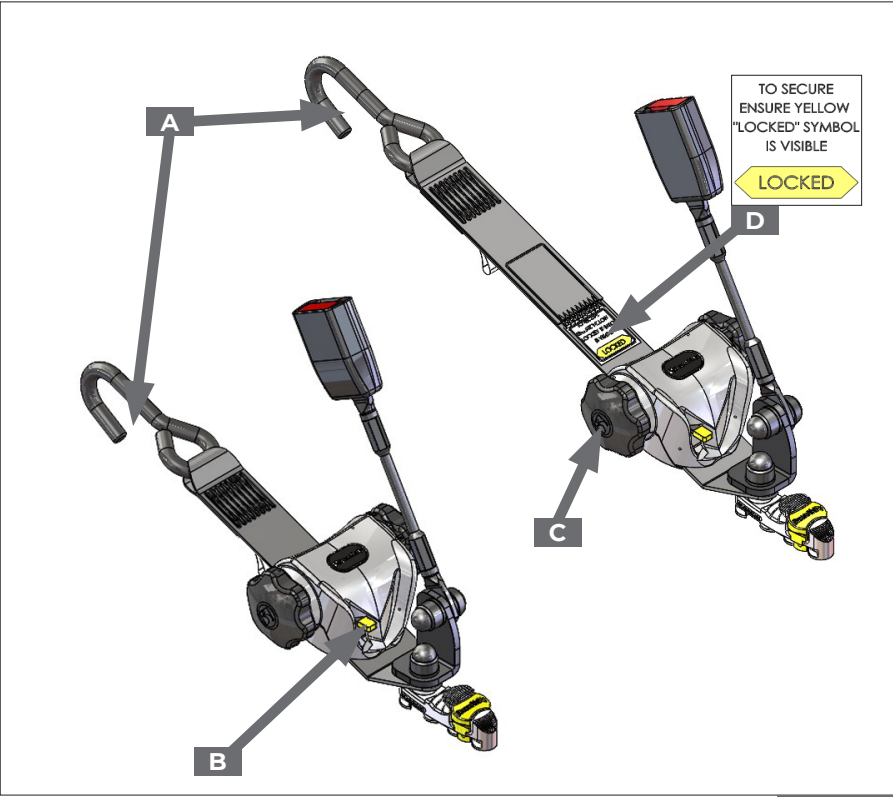

Figure 9

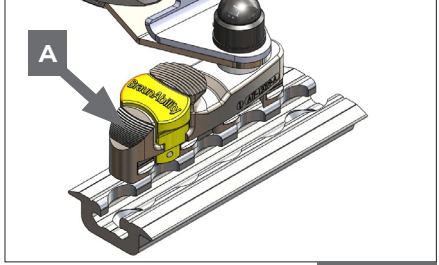

Figure 2

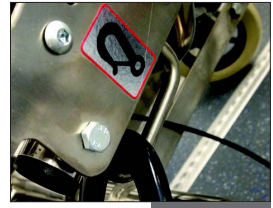
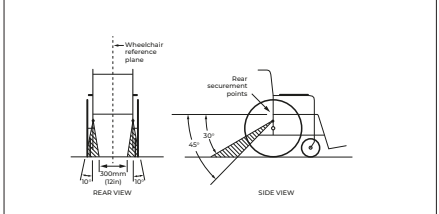

Figure 3



**NOTE** Note that angles indicated are obtained by projecting the angle of each tie-down strap onto a vertical plane parallel to the wheelchair reference plane (side view) or onto a vertical plane that is perpendicular to the wheelchair reference plane (rear view).

Figure 4

Fit and use

## Fit and use

### Classic retractable tie-downs

#### Solo anchor - fixed stalk (K- products) - rear

1. The Solo floor anchors will have been installed in the vehicle in accordance with their own and the vehicle converter's instruction. Position the wheelchair within the vehicle as required.
2. Install each front retractor cleat onto a front Solo anchor by aligning the open mouth of the cleat and the protrusion, (Fig. 11C), to the slot on the floor anchor. Slide the cleat fully home (allowing the keyway within the cleat to guide into its home position, Fig. 11A & B) and rotate the cleat through 90° to align the retractor with the wheelchair frame, (Fig. 12).
3. Dependent on retractor type, follow instruction:  
**Quattro:** Press the release button(s), (Fig. 10B), to release the webbing and attach each J-hook arrangements to the wheelchair's rear frame, with the open gate facing outboard. (Some wheelchairs will indicate this position, Fig. 3). Press the yellow button(s) again to remove the webbing slack.  
**Quattro Express:** Webbing can be extended from the reel without pressing the yellow button if the lock label, (Fig. 10D), is NOT visible. Attach each of the wheelchair attachments to the wheelchair's rear frame. (Some wheelchairs will indicate this position, Fig. 3). The yellow button must be pressed if extending webbing with the label in view, (Fig. 10B). The webbing will retract automatically into the reel. **IMPORTANT: The yellow locking label must be fully visible to ensure that the reel is locked off, (Fig. 10D).**
4. Final tensioning is achieved by turning each tensioning handle, (Fig. 10B), until the webbing is equally taut on each side.
5. Ensure that the webbing of each tie-down is approximately the same length, and at an angle of around 30 to 45°, within the rear view zone, (Fig. 8).
6. The occupant restraint must now be fitted. Please refer to relevant manual.

#### Removing the combined retractable tie-downs

#### **IMPORTANT: First remove the occupant restraint.**

1. Release the tension in the front tie-downs by pressing the yellow button, (Fig. 10B), and extending the webbing to allow the J-hook, (Fig. 10A), to be removed from the wheelchair frame. If the webbing is particularly tight, it may be necessary to slightly 'tension' the webbing with the hand wheel, (Fig 10C), while pressing the yellow button, (Fig. 10B), to remove the webbing lock on the retractor.
2. Remove each front retractor from the anchor by rotating the tie-down through 90° so that the raised protrusion, (Fig. 11C), on the cleat is facing its parallel cleat.
3. Pull the tie-down away from the floor anchor and store safely.





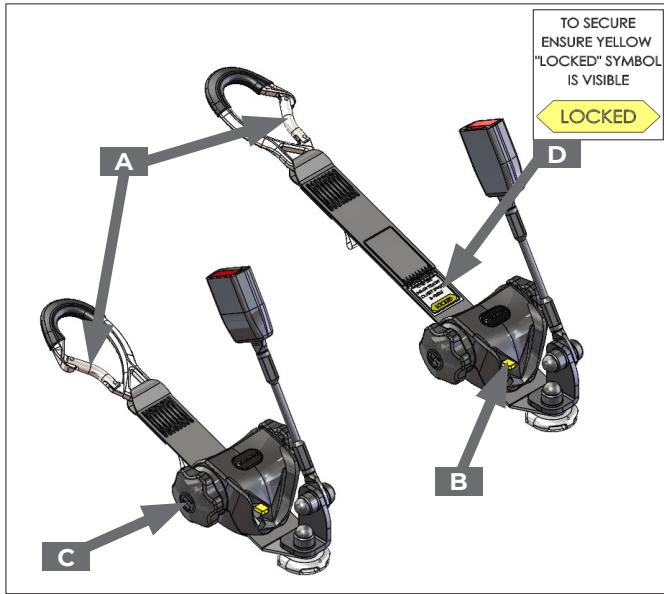

Figure 10

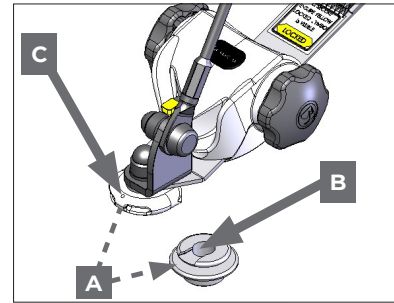

Figure 11

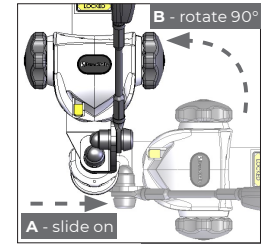

Figure 12

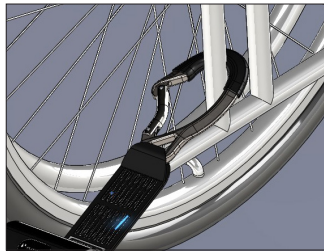
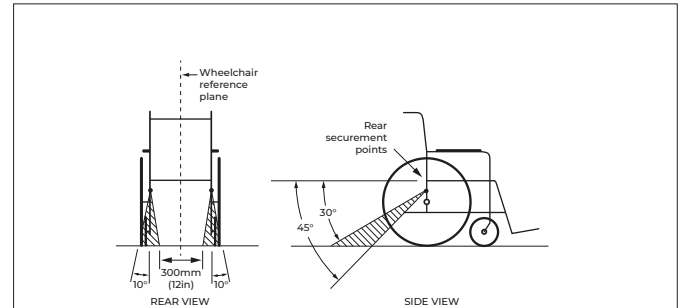

Figure 4



Figure 3



**NOTE** Note that angles indicated are obtained by projecting the angle of each tie-down strap onto a vertical plane parallel to the wheelchair reference plane (side view) or onto a vertical plane that is perpendicular to the wheelchair reference plane (rear view).

Figure 8

## After care

### Equipment storage and maintenance

- Store the restraint safely in supplied bag, off the floor, to avoid damage and ensure that it cannot become a projectile in an accident.
- Regularly inspect the wheelchair restraint systems for damage, wear or malfunction. If any problems are identified replace components immediately.
- When not in use, keep loose occupant webbing ends connected to their corresponding buckle sleeves, etc, to prevent them from becoming trip hazards and from flailing around when the vehicle is in motion.
- All webbing and components can be cleaned as necessary, but care should be taken to prevent contamination of the webbings with polishes, oils and chemicals, particularly battery acid.
- To clean the straps use warm soapy water and a clean soft cloth. Rinse with clear water and allow to air dry. To disinfect, use a mild spray disinfectant and do not use products containing bleach. **Important: when cleaning or disinfecting, do not immerse or flood buckles, karabiner fittings or floor anchors in the disinfectant or water.**
- If the vehicle is involved in an accident when any restraints are deployed, remove them from service and replace immediately. If in doubt please contact BraunAbility.

# Declaration of conformity

## Manufacturer /

BraunAbility UK Ltd  
Unwin House  
The Horseshoe Coat Road  
Martock, Somerset, TA12 6EY,  
UK

Toll Free: (800) 488-0359  
Email: [questions@braunability.com](mailto:questions@braunability.com)  
[www.braunability.eu](http://www.braunability.eu)

## Declares that the products /

I-RQE10MK, I-RQ10MT, I-RQ10PT,  
I-RQE10MH, I-RQ10PJ, I-RQ10MJ,  
I-RQE10PJ, I-RQE10MJ, I-SQE10PK,  
I-SQ10MJ, I-SQE10PJ, I-SQE10MJ  
K-RQE10MK, K-RQ10MT, K-RQ10PH,  
K-RQE10MH, K-RQ10PJ, K-RQ10MJ,  
K-RQE10MJ, K-SQE10PK, K-SQ10PJ,  
K-SQ10MJ, K-SQE10PJ, K-SQE10PJ

## Conforms to following directives standards and regulations /

214/2013/ EU Paragraphs 2.3.1 and 2.3.2  
ISO 10542:2012  
RESNA WC-4 2012 Section 18  
2001/85/EC  
R.107.06  
DIN 75078  
2018-858-EU

BraunAbility, June 2021

## Warranty

BraunAbility products are extensively tested using BraunAbility anchorage systems, and our full warranty normally only applies to BraunAbility equipment when used with BraunAbility branded anchorages or as instructed. BraunAbility have also participated in test programs with other manufacturers anchorage products and will support warranty on the BraunAbility products when used in conjunction with such jointly tested systems. For further details on specific applications please contact the Sales Office. In other situations, using BraunAbility products, for which BraunAbility has not participated in a joint test program, a limited BraunAbility warranty will apply.



Accredited by URS as testing laboratory in accordance with ISO/IEC 17025:2005  
Quality system certified in accordance with ISO 9001:2008

Illustrations, descriptions and specifications in the user manual are based on current product information. BraunAbility UK Ltd reserves the right to make alterations without previous notice.

© 2020 BraunAbility UK Ltd

**BraunAbility UK Ltd**  
Unwin House  
The Horseshoe, Coat Road  
Martock, Somerset, TA12 6EY,  
UK

Toll Free: (800) 488-0359  
Email: [questions@braunability.com](mailto:questions@braunability.com)  
[www.braunability.eu](http://www.braunability.eu)