

**Operator's Manual for:
Series 02**

VL9171B

Commercial Wheelchair Lifts



International Corporate Hdqrs: P.O. Box 310 Winamac, IN 46996 USA
1-800-THE LIFT (574) 946-6153 FAX: (574) 946-4670



28233-02
May 2003

Patent #5,261,779
Patent #6,238,169

Patent #6,065,924
Patents Pending

complying with **ADA** Americans With Disabilities Act

! WARNING

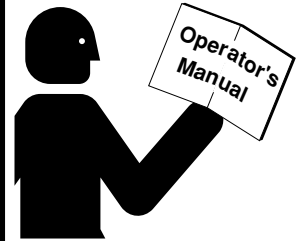

Read manual before operating lift. Failure to do so may result in serious bodily injury and/or property damage. Keep manual in lift storage pouch.

Congratulations

We at The Braun Corporation wish to express our fullest appreciation on your new purchase. With you in mind, our skilled craftsmen have designed and assembled the finest lift available.

This manual includes safety precautions, lift operating instructions, manual operating instructions, and instructions for maintenance and lubrication procedures.

Your lift is built for dependability, and will bring you years of pleasure and independence, as long as maintenance is performed regularly and the lift is operated by an instructed person.

Sincerely,

THE BRAUN CORPORATION

A handwritten signature in black ink that reads "Ralph W. Braun". The signature is written in a cursive style with a large, sweeping initial "R".

Ralph W. Braun
Chief Executive Officer

Contents

Lift Terminology

| | |
|---------------------------------------|------|
| Lift Terminology Illustration | 2 |
| Introduction | 3 |
| Direction | 3 |
| Lift Components | 4, 5 |
| Power/Interlock Indicator Light | 5 |
| Lift Actions and Functions | 6 |

Lift Operation Safety

| | |
|---|------|
| Safety Symbols | 7 |
| Lift Operation Safety Precautions | 8-11 |

Pre-Lift Operation Notes and Details

| | |
|---|--------|
| Lift Access Doors and Lift Interlocks | 12 |
| General Safety | 13 |
| Lift Control Switches | 13 |
| Lift Features | |
| Lift-Tite Latches™ | 14, 15 |
| Automatic Inboard Roll Stop | 16, 17 |

| | |
|--|--------|
| Automatic Outboard Roll Stop | 17, 18 |
| Handrails | 18, 19 |
| Interlocking Restraint Belt | 19, 20 |
| Lift Passengers | |
| Passenger Orientation (Boarding Direction) | 20 |
| Standees | 20, 21 |
| Yellow Boundaries | 21 |
| Vehicle (Floor Level) Loading and Unloading | 21, 22 |
| Wheelchair-Equipped Occupant Seat Belts | 22, 23 |
| Operation Procedure Review | 23 |
| Preventive Maintenance | 24 |
| Lift Operating Instructions | 25-29 |
| Manual Operating Instructions | 30-34 |
| Decals and Antiskid | 35-37 |
| Maintenance and Lubrication | 38, 39 |
| Warranty/Registration Instructions | 40, 41 |

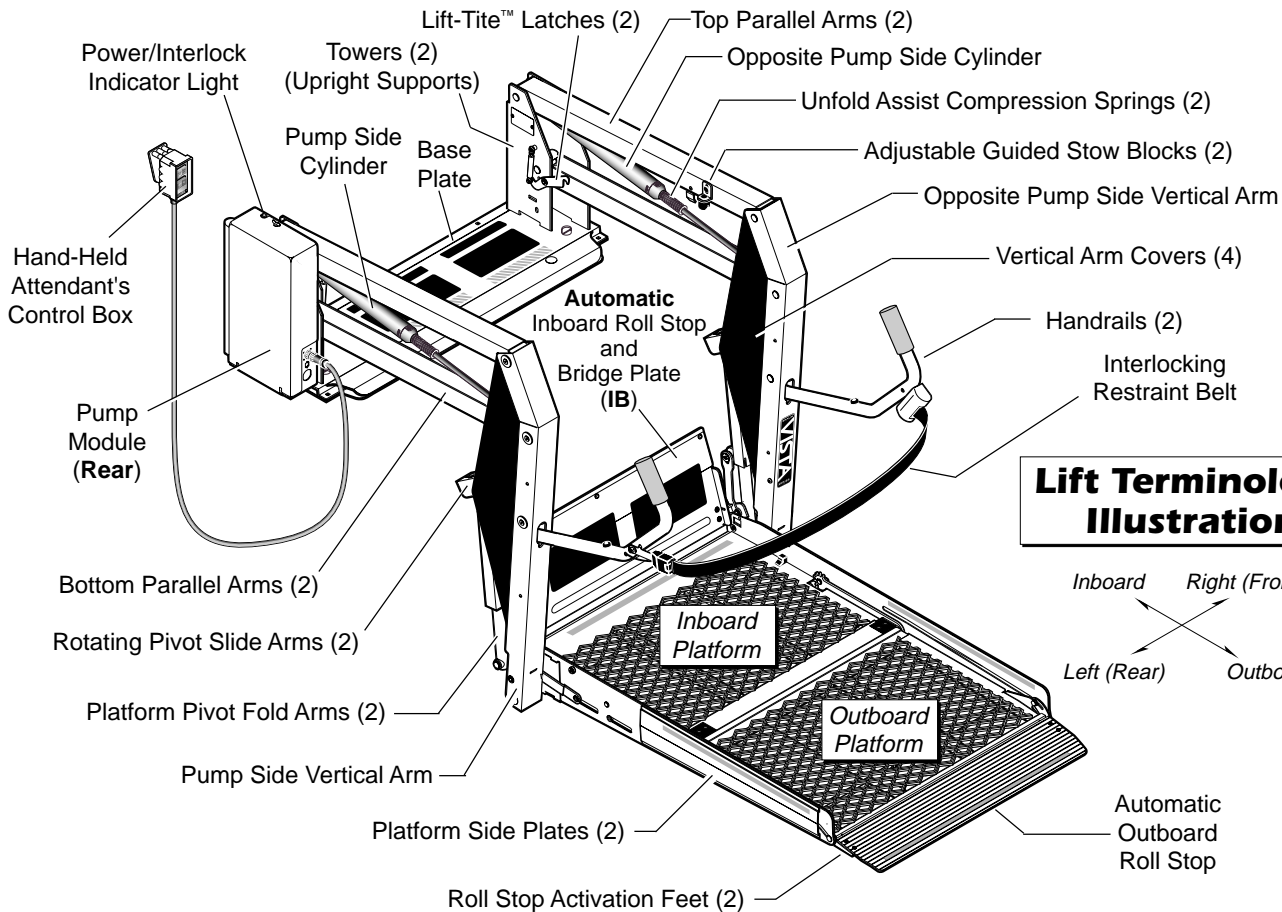

Lift Terminology Illustration

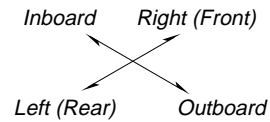

Introduction

Braun VL917 Vista Series lifts are ADA compliant and commercial oriented (intended for operation by an attendant).

VL917 Series lift models can be equipped with left or right side pump modules as needed. Lift model numbers with suffix "F" are right side (front) pump-equipped and model numbers without suffix "F" are equipped with a left side (rear) pump. A left side pump-equipped lift model is depicted in the Lift Terminology Illustration. Right side pump lift models are a mirrored image of rear pump

Lift Terminology

models (pump module located on opposite end of base plate).

Refer to the Lift Terminology Illustration for identification of lift components.

Lift operation procedures are identical for all VL917 Series lift models. The operating instructions contained in this manual and appearing on lift-posted operating instructions decals address the lift control switches and the corresponding lift functions. Instructions are provided for manual operation of the lift in event of power or equipment failure.

Terminology: Become familiar with the terminology that will be used throughout this manual. Become familiar with the identification of lift components and their functions. Contact your lift sales representative or call The Braun Corporation at 1-800-THE LIFT if any of this information is not fully understood.

Direction: The terms "left (rear)," "right (front)," "inboard," and "outboard" will be used throughout this manual to indicate direction (as viewed from outside the vehicle looking directly at the lift). Refer to the Lift Terminology Illustrations for clarification of direction terms.

Lift Terminology

Lift Components

Refer to the Lift Terminology Illustration on page 2.

Pump Module: The lift-mounted pump module consists of the hydraulic pump, the manual hand pump and electrical components that power the lift electric/hydraulic systems. **Note:** A green power/interlock indicator light is built into the pump module (see page 5 for further details).

Hand-Held Switch Control Box: The “quick-disconnect” hand-held control switchbox is connected to the pump module. “Quick-disconnect” hand-held controls are available with three types of cable (standard, armored and coiled).

The control box is equipped with two color-coded rocker switches, (UNFOLD/FOLD and DOWN/UP). The switches activate the automatic lift functions. Details regarding the control switches and their functions are provided in the Pre-Lift Operation section (page 13).

Lift Frame: The lift frame consists of the base plate, two towers, the parallel arms, the vertical arms, platform pivot arms and the handrails. The two main hydraulic cylinders are housed in the parallel arms. The electrical/hydraulic powered lift frame components mechanically unfold, lower, raise and fold the lift platform assembly.

Platform Assembly: The lift

“stacking” platform assembly is made up of an inboard platform section and an outboard platform section (each section consisting of a steel tubing frame with grating surface). The inboard roll stop and bridge plate assembly (IB) is mounted to the inboard platform section. The outboard platform section is equipped with the outboard roll stop.

Lift-Tite™ Latches: The spring loaded latches prevent the platform from unfolding from the stowed position in the event of platform drift. Further details regarding Lift-Tite™ latches are provided on pages 14 and 15.

Outboard Roll Stop: The spring loaded automatic outboard roll stop provides a ramp for wheel-

chair loading and unloading at ground level. Photos and further details regarding the outboard roll stop are provided in the Pre-Lift Operation Notes section (pages 17 and 18).

Automatic Inboard Roll Stop and Bridge Plate: VL917 lift models are equipped with an automatic inboard roll stop that also serves as the bridge plate. The bridge plate bridges the gap between the lift platform and the vehicle floor. The roll stop/bridge plate automatically rotates from the horizontal (bridging) position to the vertical (roll stop) position as the lift lowers and raises. Further details regarding the automatic mechanical inboard roll stop are provided on pages 16 and 17.

Lift Terminology

Power/Interlock Indicator Light:

A green indicator light is built into the pump module that illuminates when remote interlock(s) are made (circuit complete), there is power to the lift and the interlocking handrail belt is buckled. All three conditions must be met. The light will shut off if the handrail belt is unbuckled (lift functions are disabled also). An illuminated light indicates the lift is operational.



Lift Terminology

Lift Actions and Functions

UNFOLD (Out) - Platform

Unfold: Unfold is the action of the platform rotating out and down from the fully-stowed (vertical) position to floor level (horizontal) position when the UNFOLD switch is pressed.

DOWN - Platform Lower: Down is the action of the platform lowering from floor level position to fully-lowered (ground level) position when the DOWN switch is pressed.

DOWN - Roll Stop Unfold (Deploy) - When the platform reaches the fully-lowered (ground) position and the DOWN switch is continued to be pressed,

the outboard roll stop rotates downward from vertical position to ramp position.

UP - Platform Raise: Up is the action of the platform raising from ground level to floor level (fully-raised) position when the UP switch is pressed.

UP - Roll Stop Fold (Raise): As the platform begins to raise off the ground, the spring-loaded roll stop rotates from ramp position to vertical position.

FOLD (In) - Platform Fold: Fold is the action of the platform rotating up and in from the floor level (horizontal) position to fully-stowed (vertical) position when the FOLD switch is pressed.

Stowed Position: The lift is stowed when the lift platform has been fully raised and folded fully (vertical position).

Floor Level: Floor level is the position (height) the platform assembly reaches in order for the wheelchair passenger to enter and exit the vehicle (fully raised). The platform automatically stops at floor level when unfolding from the stowed position and when raising from ground level.

Note: Further details regarding lift control switches and the corresponding lift functions are provided in the Pre-Lift Operation Notes and Details section.

Lift Operation Safety

Safety Symbols

SAFETY FIRST! Know That...

A All information contained in this manual and supplements (if included), is provided for your safety. Familiarity with proper operation instructions as well as proper maintenance procedures are necessary to ensure safe, troublefree operation. Safety precautions are provided to identify potentially hazardous situations and provide instruction on how to avoid them.

B



C

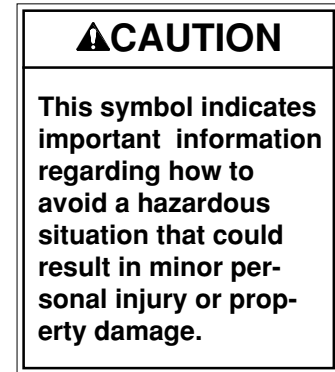

D **Note:** Additional information provided to help clarify or detail a specific subject.

These symbols will appear throughout this manual as well as on the labels posted on your lift. **Recognize the seriousness of this information.**

Lift Operation Safety

Lift Operation Safety Precautions

⚠️ WARNING

If the lift operating instructions, manual operating instructions and/or lift operation safety precautions are not fully understood, contact The Braun Corporation immediately. Failure to do so may result in serious bodily injury and/or property damage.

⚠️ WARNING Read manual and supplement(s) before operating lift. Read and become familiar with all safety precautions, pre-lift operation notes and details, operating instructions and manual operating instructions before operating the lift. **Note:** Wheelchair passengers and all transit agency personnel (drivers and wheelchair lift attendants) must read and become familiar with the contents of this manual and supplement(s) before operation.

⚠️ WARNING Load and unload on level surface only.

⚠️ WARNING Engage vehicle parking brake before operating lift.

⚠️ WARNING Provide adequate clearance outside the vehicle to accommodate the lift before opening lift door(s) or operating lift.

⚠️ WARNING Inspect lift before operation. Do not operate lift if you suspect lift damage, wear or any abnormal condition.

⚠️ WARNING Keep operator and bystanders clear of area in which the lift operates.

Lift Operation Safety

⚠️WARNING

Whenever a wheelchair passenger (or standee) is on the platform, the:

- Handrail belt must be latched.
- Passenger must be positioned fully inside yellow boundaries
- Wheelchair brakes must be locked
- Roll stops must be up (vertical)
- Roll stop latch must be fully engaged
- Passenger should grip both handrails (if able).

⚠️WARNING

Load and unload clear of vehicular traffic.

⚠️WARNING

Do not overload or abuse. The load rating applies to both the raising and lowering functions - continuous lifting capacity is 800 lbs.

⚠️WARNING

Do not operate or board the lift if you or your lift operator are intoxicated.

⚠️WARNING

Do not raise front wheelchair wheels (pull wheelie) when loading (boarding) the platform.

⚠️WARNING

Open lift door(s) fully and secure before operating lift.

⚠️WARNING

Position and secure (buckle, engage, fasten, etc.) the wheelchair-equipped occupant seat belt (torso restraint) before loading onto the wheelchair lift platform.

⚠️WARNING





Lift attendants must ensure that lift occupants keep hands, arms and all other body parts within the lift occupant area and clear of moving parts.

Lift Operation Safety

Lift Operation Safety Precautions (continued)

WARNING

If the lift operating instructions, manual operating instructions and/or lift operation safety precautions are not fully understood, contact The Braun Corporation immediately. Failure to do so may result in serious bodily injury and/or property damage.

-  **WARNING** Platform must be positioned at floor level (bridge plate height) when loading or unloading in and out of vehicle.
-  **WARNING** Do not use platform roll stops as a barrier (brake). Stop and brake wheelchair when loading onto the platform (manually stop and brake manual wheelchairs — stop powered wheelchairs with the wheelchair controls).
-  **WARNING** Turn powered (electric) wheelchairs off when on lift platform.
-  **WARNING** Press the DOWN switch until the entire platform rests on ground level (lowered fully) and the outboard roll stop is fully unfolded (ramp position) before loading or unloading a passenger at ground level.
-  **WARNING** Outboard platform roll stop must be fully unfolded (ramp position) until front and rear wheelchair wheels cross roll stop when loading or unloading at ground level.

 **WARNING** Accidental activation of control switch(es) may cause unintended operation(s).

Lift Operation Safety

- ⚠️ WARNING** Maintenance and lubrication procedures must be performed as specified in this manual by authorized (certified) service personnel.
- ⚠️ WARNING** Replace missing, worn or illegible decals.
- ⚠️ WARNING** Keep owner's (operator's) manual in lift-mounted manual storage pouch at all times.
- ⚠️ WARNING** Never modify (alter) a Braun Corporation lift.
- ⚠️ WARNING** Do not use accessory devices not authorized by The Braun Corporation.
- ⚠️ WARNING** Do not remove any guards or covers.
- ⚠️ WARNING** Keep clear of any hydraulic leak.
- ⚠️ WARNING** Failure to follow these safety precautions may result in serious bodily injury and/or property damage.

Pre-Lift Operation Notes and Details

WARNING

Read and become familiar with all lift operation safety precautions, pre-lift operation notes and details, operating instructions and manual operating instructions prior to operating the lift. If this information is not fully understood, contact The Braun Corporation immediately. Failure to do so may result in serious bodily injury and/or property damage.

VL917 Series lift models are specifically designed to be operated by an attendant. The Lift Operating Instructions contained in this manual and posted on the lift provide instructions for operation of the lift **only**. Read and become familiar with all lift operation safety precautions, pre-lift operation notes and details, operating instructions and manual operating instructions before attempting lift operation procedures.

Lift Access Doors and Lift Interlocks: Attendants **must** become familiar with the vehicle lift access door system and the interlock system (if equipped), as well as the proper operation of the lift. Transit vehicles and lift access door configurations vary. Door securement devices (latches, hooks, cables, etc.) and procedures to operate

them vary.

Lift interlocks are required by nearly all transit authorities. Instructions for operation of interlocks and door securement systems cannot be addressed in this manual or on lift-posted operating instructions decals due to the variety of procedures required for operating them. **Note:** A green indicator light is built into the pump module that illuminates when remote interlock(s) are made (see page 5 for further details).

It is the responsibility of the lift operator (attendant) to properly open, secure and close the vehicle lift door(s), to activate the lift interlock (if equipped), to load and unload the wheelchair passenger (or standee) on and off the lift platform, and to properly activate all lift functions.

Pre-Lift Operation Notes and Details

General Safety: The lift operator (attendant) and bystanders must keep clear of the area in which the lift operates and clear of all moving parts. Lift attendants must ensure that lift

occupants (passengers) keep hands, arms and all other body parts within the lift occupant area and clear of moving parts.

Lift Control Switches

The hand-held attendant's control box provides an orange UNFOLD/FOLD (Out/In) switch and a red DOWN/UP switch. The control switches are color-coded to correspond to the color coding and switch function labels that appear on the lift-posted operating instructions decal.

Triangular-shaped color-coded symbols (▶) appear on the lift operating instructions decal. The color of the symbol corresponds to the color of the corresponding switch. The direction (point) of the symbol corresponds with the direction the switch should be pressed (activated) to produce the intended lift function.

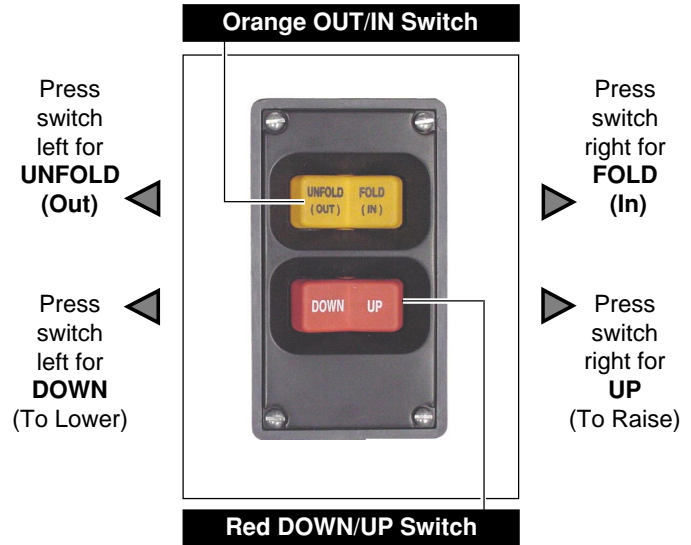

Pre-Lift Operation Notes and Details

Lift Features

Become familiar with all lift features and the proper operation of the lift components **before** attempting lift operation. Refer to the Lift Terminology Illustrations for identification of specific lift components if not

clearly depicted in this section. Contact The Braun Corporation at 1-800-THE LIFT immediately if any of this information is not understood.

Lift-Tite™ Latches: VL917 Vista Series lifts are equipped with Lift-Tite™ Latches. Lift-Tite™ Latches prevent the platform from unfolding from the stowed position in

!WARNING

Discontinue lift use immediately if any lift component does not operate properly. Failure to do so may result in serious bodily injury and/or property damage.

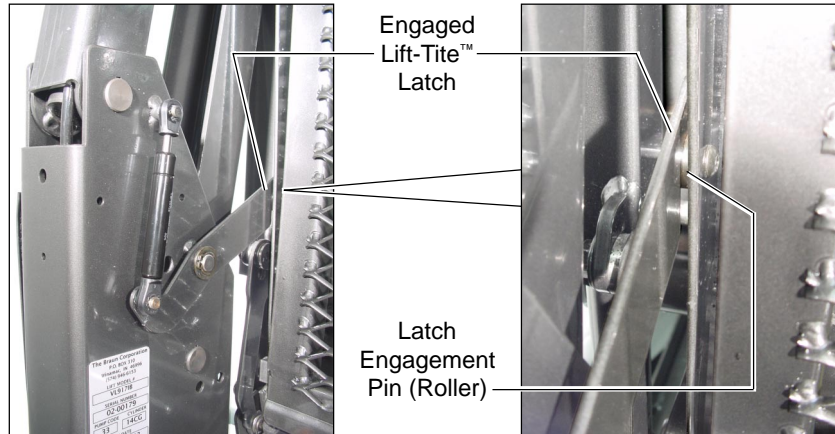

Pre-Lift Operation Notes and Details

the event of platform drift. Due to the “all-hydraulic” operation of the dual-cylinder VL917, hydraulic fluid expansion, contraction or seepage may occur. Any of these conditions may result in platform drift (failure to hold the platform in the folded or raised position). Platform drift may occur during lift shipment and/or between extended periods of non-lift use.

In the event the platform does not unfold when the UNFOLD switch is pressed, press the FOLD switch momentarily to disengage the Lift-Tite™ latches (platform drift has occurred). Then, press the UNFOLD switch to unfold the platform to floor level (standard operation).

When manually operating a lift equipped with Lift-Tite™ latches, insert the pump handle in the pump and stroke until the platform folds fully (stops). Then, open the hand pump valve (turn counterclockwise) to unfold the

platform.

Folding the platform fully first will ensure that the Lift-Tite™ latches will disengage properly when the release valve is opened (in event of platform drift). Manual

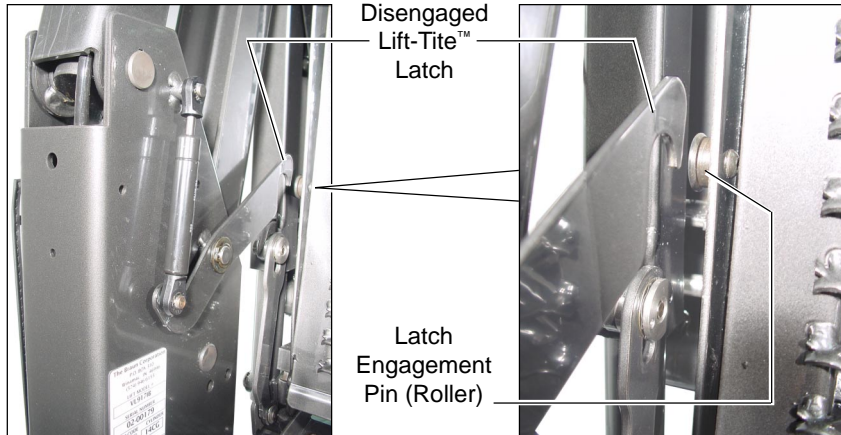

Pre-Lift Operation Notes and Details

Lift Features (continued)

Operating Instructions are provided on pages 30-34.

Automatic Inboard Roll Stop and Bridge Plate: VL917IB lift models are equipped with an automatic inboard roll stop that also serves as the bridge plate

(automatic inboard roll stop photos below).

When the UNFOLD switch is pressed and the platform unfolds from stow position to floor level, the roll stop/bridge plate is automatically deployed to the bridging (horizontal) position to provide a bridge plate between

the platform and the lift base plate (vehicle floor). The inboard edge of the bridge plate rests on the lift base plate.

The roll stop/bridge plate automatically folds (rotates) to the vertical (roll stop) position when the platform lowers to the ground (DOWN switch is pressed).

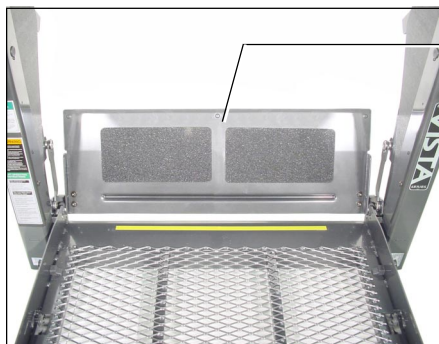

Fully Folded
(vertical)
Inboard
Roll Stop

Fully Unfolded
(horizontal)
Inboard Roll Stop
(bridging position)

Automatic Inboard Roll Stop and Bridge Plate "IB"

The inboard roll stop "IB" **must overlap** the base plate a **minimum 1/2"**.

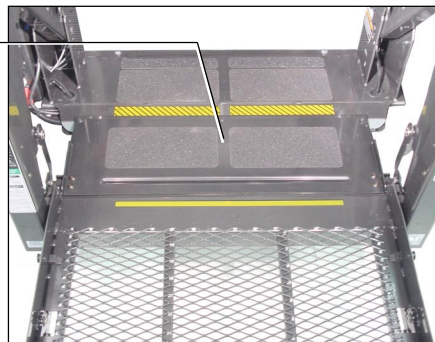

Pre-Lift Operation Notes and Details

⚠ WARNING

Discontinue lift use immediately if any lift component does not operate properly. Failure to do so may result in serious bodily injury and/or property damage.

As the UP switch is pressed and the platform raises from ground level, the roll stop/bridge plate automatically unfolds (rotates) to the horizontal (bridging) position when it reaches vehicle floor level. The roll stop must overlap the lift base plate a minimum 1/2".

When the FOLD switch is pressed and the platform folds from floor level to the stow (vertical) position, the roll stop/bridge plate automatically travels inboard to the stowed position.

Read warning posted at left. Discontinue lift operation immediately if the roll stop does not operate properly.

Automatic Outboard Roll Stop: The outboard roll stop provides a ramp for wheelchair loading and unloading at ground level (see photos at right). When the platform lowers fully to ground level, the roll stop activation feet automatically unfold (rotate) the roll stop down to the ramp position (fully unfolded). The two

Fully-Folded Roll Stop (Up-vertical)

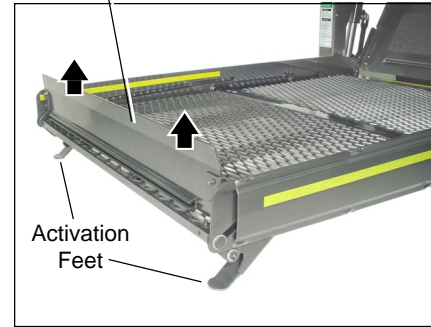

Fully-Unfolded Roll Stop (Ramp position)

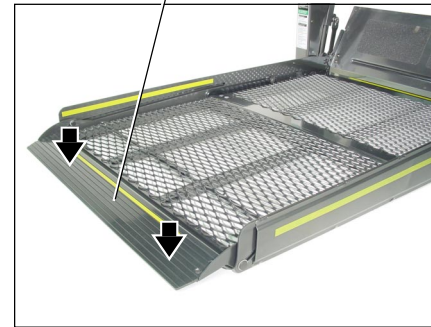

Pre-Lift Operation Notes and Details

Lift Features (continued)

activation feet (one at both ends of the roll stop) ensure roll stop operation on an uneven surface.

The roll stop is spring-loaded to automatically fold (rotate) to the vertical position when the UP switch is pressed. As the activation feet lift off the ground, the torsion springs rotate the roll stop to the vertical position.

Note: The platform raises approximately two inches **before** the roll stop reaches the fully UP position. **Discontinue lift operation immediately if the roll stop does not operate properly.**

Outboard Roll Stop Operation:

The lift operator (attendant) must press the DOWN switch to lower the platform fully to the ground. The attendant **must view** the platform as it lowers to **be certain** the **entire platform** reaches and rests safely on the ground. Stop pressing the DOWN switch if any portion of the platform is obstructed while descending or the entire platform does not reach ground level **for any reason** (contact with an obstruction, mechanical failure, exceeding the lift “floor-to-ground” capacity, etc.).

After the platform is fully lowered (entire platform reaches the ground), the roll stop **must remain in the fully unfolded** (ramp) position until the entire

wheelchair (or standee) has crossed the roll stop when loading or unloading at ground level. When raising the platform, the lift operator (attendant) **must view** the platform as it raises to **ensure** the roll stop rotates to the vertical position. **Discontinue lift operation immediately if the roll stop does not operate properly.**

Handrails: Dual handrails are provided for wheelchair passenger (or standee) use. The handrails unfold automatically to the deployed (horizontal) position when the lift unfolds and automatically fold to the stowed (vertical) position when the platform folds.

Passengers should grip both

Pre-Lift Operation Notes and Details

handrails when on the lift platform if able. **Discontinue lift operation immediately if the handrails do not operate properly.**

Interlocking Restraint Belt: The VL917IB is equipped with an occupant restraint belt. The belt assembly is mounted to the lift handrails. The receptacle is mounted to the left

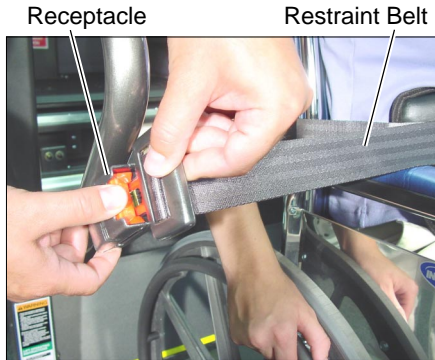

(rear) handrail. The buckle portion of the belt retracts for automatic storage of the belt.

Interlock Feature: Power lift functions cannot be activated if the restraint belt is not latched (buckled). A green indicator light is built into the pump module that illuminates when the belt is latched (see page 5 for further details).

When loading a passenger at ground level, the attendant must latch the belt after the passenger has loaded onto the platform. Standees must stand inboard of the belt and grip the handrails (if able) when on the lift platform. The restraint belt **must** be latched whenever a passenger is on the platform.

After the lift platform has been raised to floor level position and the passenger has loaded into the vehicle, the belt remains buckled (allowing the platform to be folded to the stowed position). The buckled interlock belt then allows the platform to be unfolded to floor level when unloading a passenger or

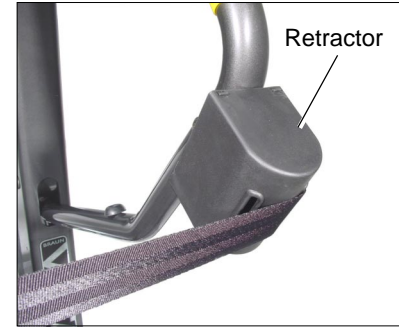

Pre-Lift Operation Notes and Details

Lift Features (continued)

deploying the lift. The belt **must** be latched before loading a passenger onto the platform from inside the vehicle.

When the platform has been lowered to ground level, the attendant must unlatch the belt to allow the passenger to exit the platform.

Lift Passengers

If you are an attendant operating the lift, it is your responsibility to perform safe loading and unloading procedures. Wheelchair lift attendants should be instructed on any special needs and/or

procedures required for safe transport of wheelchair passengers.

The lift operator and bystanders must keep clear of the area in which the lift operates. Observe your passenger at all times during lift operation.

Do not attempt to load or unload a passenger in a wheelchair or other apparatus that does not fit on the platform area. Do not exceed the 800 pound load capacity of the lift. The lift attendant should not ride on the platform with the passenger.

Passenger Orientation (Boarding Direction): Braun VL917 Series **ADA** wheelchair lifts **fully comply** with the ADA requirement that the lift accommodate **both**

inboard and outboard facing wheelchair passengers **or** standees. Inboard facing of wheelchair lift passengers is **not prohibited**, but outboard facing of passengers is **recommended** by The Braun Corporation.

Braun VL917 Series **ADA** certified lifts permit both inboard and outboard facing of wheelchair and mobility aid users **and** accommodate persons using walkers, crutches, canes or braces or who otherwise have difficulty using steps **as specified** in Americans With Disabilities Act (ADA) Accessibility Specifications For Transportation Vehicles-Part 38.

Standees: Lift Operating Instructions apply to wheelchair passengers and standees. Standees

Pre-Lift Operation Notes and Details

should stand in the center of the platform (inboard of restraint belt and inside yellow boundaries) and grip both handrails (if able) when on platform.

Yellow Boundaries: The passenger **must** be positioned in the **center of the platform** to prevent side-to-side load imbalance. The lift attendant (operator) should **not** ride on the platform with the passenger.

Yellow platform loading boundaries are identified in the following manner. Yellow boundary strip decals are affixed to the platform side plates and yellow plastic caps are placed on the dual handrails to define the left-to-right boundaries. Inboard and outboard loading boundaries are

identified with a yellow boundary strip decal affixed to the inboard end (heel) of the platform and a yellow boundary strip decal affixed to the extruded aluminum outboard roll stop.

The attendant must always be certain the wheelchair passenger or standee is properly positioned on the platform (fully inside yellow boundaries and inboard of the restraint belt). The attendant must also ensure the wheelchair brakes are locked when a passenger is on the lift platform. The lift passenger must keep hands, arms and all other body parts within the lift occupant area and clear of all moving parts.

Vehicle (Floor Level) Loading and Unloading: The platform

must be fully raised (at floor level) and the bridge plate must be properly positioned when loading or unloading passengers in or out of the vehicle. **It is the responsibility of the lift operator (attendant) to ensure the platform and the bridge plate are properly positioned at floor level when loading and unloading passengers.**

The handrail **belt must be latched**, the wheelchair **brakes must be locked** and the outboard roll stop must be in the **fully-up** (vertical) position **whenever a passenger is on the platform.**

Do not use the outboard roll stop as a barrier (brake). Stop and brake the wheelchair when fully loaded on the platform. Manually

Pre-Lift Operation Notes and Details

Lift Passengers (continued)

WARNING

Whenever a passenger is on the platform, the:

- Handrail belt must be latched
- Passenger must be positioned fully inside yellow boundaries
- Wheelchair brakes must be locked
- Roll stop(s) must be UP

Failure to follow these rules may result in serious bodily injury and/or property damage.

stop and brake manual wheelchairs. Stop powered wheelchairs with the wheelchair controls. Turn powered (electric) wheelchairs off when on the platform.

If the roll stop, bridge plate, handrails, restraint belt or any other lift component does not operate as outlined in this manual, **discontinue lift use immediately** and contact The Braun Corporation sales representative in your area or call The Braun Corporation at 1-800-THE LIFT. One of our national Product Support representatives will direct you to an authorized service technician who will inspect your lift.

WARNING

Discontinue lift use immediately if any lift component does not operate properly. Failure to do so may result in serious bodily injury and/or property damage.

Wheelchair-Equipped Occupant Seat Belts

The Braun Corporation recommends wheelchair passengers position and buckle their wheelchair-equipped seat belt (torso restraint) **before** loading onto a wheelchair lift.

Pre-Lift Operation Notes and Details

Different types of disabilities require different types of wheelchairs and different types of wheelchair-equipped occupant restraint belt systems (torso restraints). It is the responsibility

of the wheelchair passenger to have his or her wheelchair equipped with an occupant restraint (seat belt) under the direction of their health care professional.

Wheelchair lift attendants should be instructed on any special needs and/or procedures required for safe transport of wheelchair passengers.

⚠️ WARNING

Position and secure (buckle, engage, fasten, etc.) the wheelchair-equipped occupant seat belt before loading onto the wheelchair lift platform. Failure to do so may result in serious bodily injury and/or property damage.

Operation Procedure Review

The Braun Corporation recommends that transit agency supervisors and wheelchair lift attendants review the safety precautions and operation procedures appearing in this manual and on lift-posted decals with your wheelchair lift sales representative (dealer), **before** attempting lift operation.

Any questions or concerns can be answered by the sales representative at that time. Operate the lift through all functions with your sales representative on hand to ensure the proper use and operation of the wheelchair lift is understood.

Transit agency supervisors should train and educate their lift attendants on the proper use and operation of the wheelchair lift if it is not possible for the attendants to review the safety precautions and operation procedures with the wheelchair lift sales representative.

The lift owner's (operator's) **manual must be stored in the lift-mounted manual storage pouch at all times.**

Pre-Lift Operation Notes and Details

Preventive Maintenance:

Maintenance is necessary to ensure safe and troublefree lift operation. General preventive lift maintenance consisting of

careful inspections of the lift system and cleaning the lift should be a part of your transit agency's daily lift service program. Simple inspections can detect potential lift operational problems.

of the procedures specified in the Maintenance and Lubrication Schedule provided in the applicable lift installation and service manual. Refer to the Maintenance and Lubrication section in this manual for further details.

WARNING

Maintenance and lubrication procedures must be performed by authorized service personnel as specified in the applicable installation/service manual. Failure to do so may result in serious bodily injury and/or property damage.

Regular preventive maintenance will reduce potential lift operation downtime and increase the service life of the lift, as well as possibly detecting potential hazards.

Exposure to harsh weather elements, environmental conditions, or heavy usage may require more frequent maintenance and lubrication procedures.

Preventive maintenance visual inspections **do not** take the place

Lift Operating Instructions

⚠️ WARNING

Read and become familiar with all lift operation safety precautions, pre-lift operation notes and details, operating instructions and manual operating instructions prior to operating the lift. If this information is not fully understood, contact The Braun Corporation immediately. Failure to do so may result in serious bodily injury and/or property damage.

⚠️ WARNING

Whenever a passenger is on the platform, the:

- Handrail belt must be latched
- Passenger must be positioned fully inside yellow boundaries
- Wheelchair brakes must be locked
- Roll stop(s) must be UP

Failure to follow these rules may result in serious bodily injury and/or property damage.

- Refer to the Lift Terminology Illustrations and the photos appearing in the Pre-Lift Operating Notes and Details section for identification of lift components. Contact The Braun Corporation immediately if not understood (call 1-800-THE LIFT).
- Follow the Manual Operating Instructions provided on pages 30-34 in event of power or equipment failure.

Note: Engage vehicle parking brake **before** operating lift.

Lift Operating Instructions



Open Door(s) and Secure

To Unfold Platform (Out):

Stand clear and press the orange UNFOLD (Out) switch until the platform stops (reaches **floor level** - unfolds **fully**). Release switch.

Note: In event platform does not unfold, press FOLD switch to release Lift-Tite™ latches.

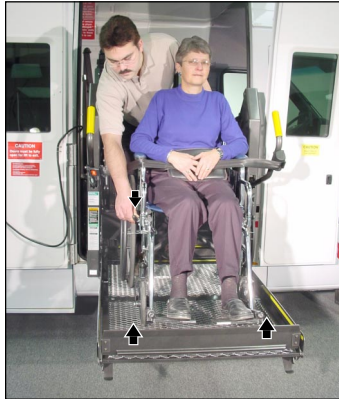
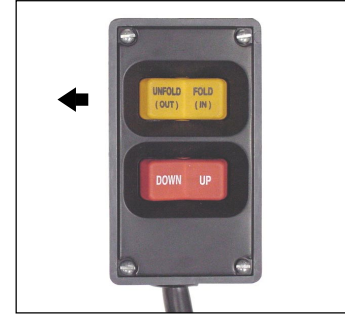

To Unload Passenger:

1. **Note:** Handrail belt **must** be latched and outboard roll stop **must** be UP. Passenger **must** be positioned fully inside yellow boundaries.

Load passenger onto platform and **lock** wheelchair brakes.

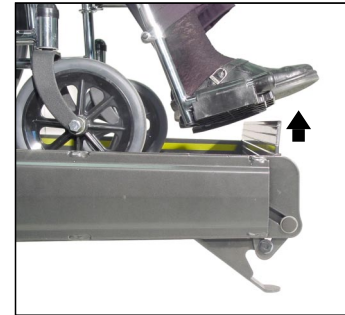

Lift Operating Instructions

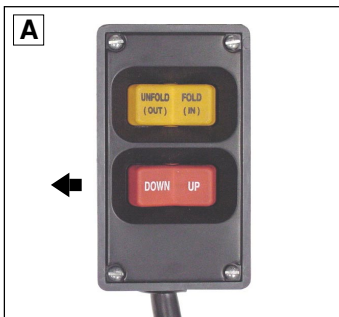

To Unload Passenger (continued):

- ◀ 2. Press red DOWN switch until the **entire** platform reaches ground level and the outboard roll stop **unfolds fully** (ramp position). See Photo **B**. Release switch. ▶

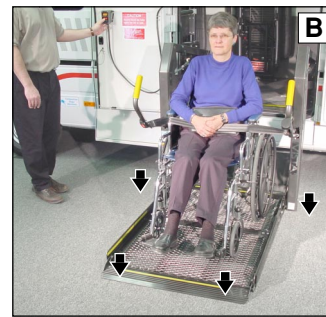

- ◀ 3. Unlatch handrail belt. See Photo **C**. ▶

4. Unlock wheelchair brakes and unload passenger from platform. ▶

Note: Roll stop **must** be **fully unfolded** (ramp position) until the entire wheelchair (or standee) has crossed the roll stop. See Photos **E** and **F** on page 28 also. ▶



Lift Operating Instructions

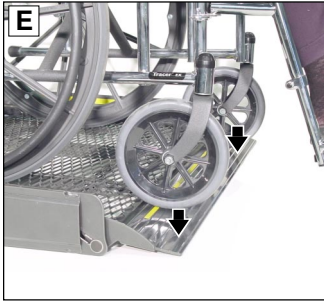

To Load Passenger:

1. **Read Note below!** Load passenger onto platform and **lock** wheelchair brakes. See Photo **G**.

Note: Roll stop **must** be **fully unfolded** (ramp position) until the entire wheelchair (or standee) has crossed the roll stop. See Photos **E** and **F**.

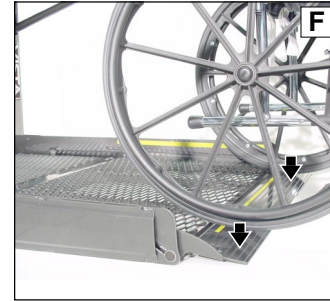

2. Latch (buckle) handrail belt. See Photo **H**.



Lift Operating Instructions

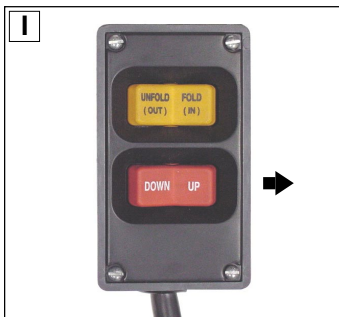

To Load Passenger (continued):

◀ 3. Press red UP switch (Photo I) to fold outboard roll stop UP **fully** (vertical), and raise the platform to **floor level**. ▶ See Photo J. Release switch.

4. Unlock wheelchair brakes and unload passenger from platform.

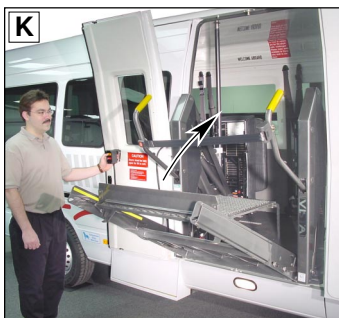
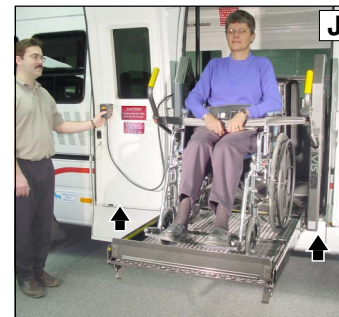

To Fold Platform (In):

◀ Press orange FOLD (In) switch until platform stops (**fully** folded). See Photos K and L. Release switch. ▶

Close Door(s)

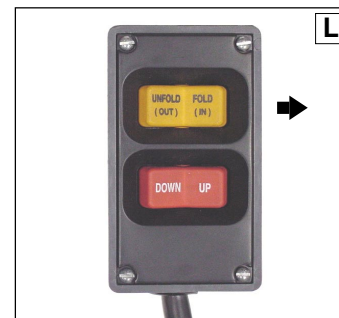

Manual Operating Instructions

If you experience power or equipment failure, refer to the Manual Operating Instructions to operate the lift. Instructions and photos are provided for all steps

that differ from standard lift operation procedures. Manual Instructions Decal #29082 (posted inside pump cover) provides manual operating

instructions also. **Note:** A rear pump lift model is depicted in the photos. Front pump applications are a mirrored image. Refer to the Lift Operating Instructions for all normal

Turn wing 1/4 turn.



Pump Cover



Hand Pump Handle

Rotate top clip to access handle.



Manual Operating Instructions

lift operation procedures (such as loading and unloading passengers). **Follow all Lift Operation Safety Precautions!**

Remove the pump cover to gain access to the pump handle and the hand pump. See photos on page 30. To remove the pump cover, turn the wing nut located

on top 1/4 turn and lift the pump cover off. The pump handle is inside this cover secured by two clips. Rotate the top clip to remove the pump handle.

The diagram illustrates the manual operating instructions for the lift's pump system. It includes a photograph of the lift's side panel with a callout 'A' pointing to the pump area. A line connects this callout to a detailed view of the hand pump and release valve. The hand pump is labeled 'Hand Pump' and the release valve is labeled 'Release Valve'. To the right of the detailed view is a circular diagram of the release valve with arrows indicating 'OPEN' (counter-clockwise) and 'CLOSE' (clockwise) directions. A vertical dashed line through the center of the valve is labeled 'seats (stops)'. Three arrows point to the valve's edge with labels: 'maximum 30 inch lbs', 'minimum 15 inch lbs', and 'seats (stops)'. A box above the diagram states 'approximate 1/16" intervals'. To the right of the diagram is the 'Valve Tightening Specification' text.

Note: Close backup pump release valve securely **before** operating electric pump.

Valve Tightening Specification: Once valve seats (stops), tighten 15 to 30 inch pounds as shown.

Manual Operating Instructions

Remove pump cover to access hand pump and pump handle as outlined on page 30. Refer to release valve photos and illustration on page 31.

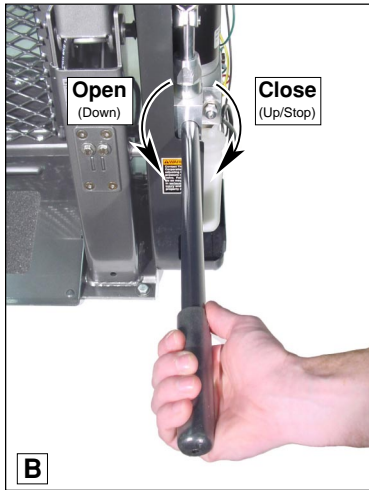

To Unfold Platform (Out):

Using hand pump handle (Photo B):

1. Close hand pump valve (place slotted end of pump handle onto backup pump release valve and turn **clockwise**).
2. Insert handle in pump and stroke until platform folds fully (stops).
3. Open hand pump valve (turn **counterclockwise**) until platform reaches floor level. **Open 1/2 turn only.**
4. Close hand pump valve (turn **clockwise**).

Note: Valve must be tight, but **do not** overtighten.

DOWN • To Lower Platform:
• To Unfold Roll Stop:

Place slotted end of pump handle

onto backup pump release valve and turn **counterclockwise** (open — **1/2 turn only**) until the platform reaches ground level and roll stop unfolds.

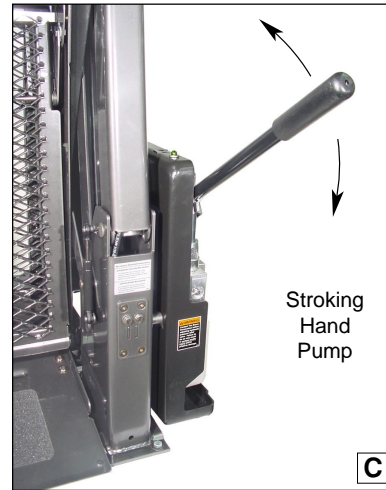

Manual Operating Instructions

Remove pump cover to access hand pump and pump handle as outlined on page 30. Refer to release valve photos and illustration on page 31.

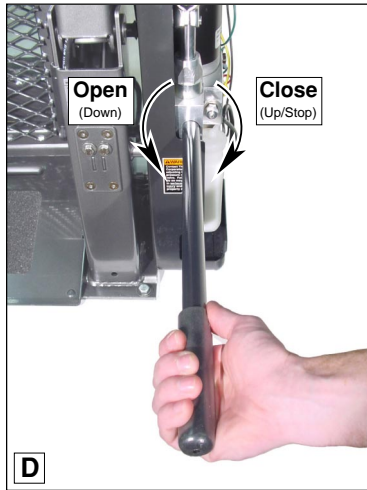

UP

- To Fold Roll Stop:
- To Raise Platform:

Using hand pump handle:

1. Place slotted end of pump handle onto backup pump release valve and turn **clockwise** to close securely. See Photo D.

Note: Valve must be tight, but **do not** overtighten.

2. Insert handle into backup pump and stroke until platform reaches **floor level** (see Photo E).

To Fold Platform (In):

Insert handle into backup pump and stroke until platform **stops** (folds **fully**). See Photo E.

Note: Close backup pump release valve securely **before** operating electric pump.

Store pump handle and install pump cover as outlined on page 34.

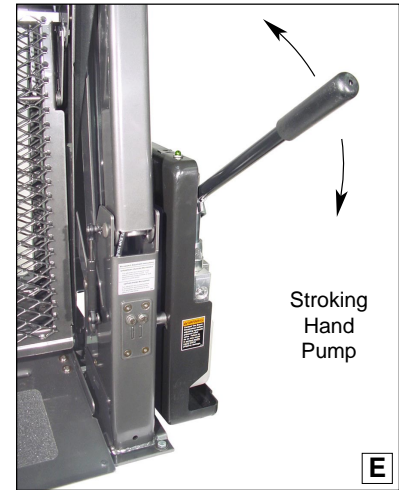

Manual Operating Instructions

To Store Pump Handle:

1. Insert bottom of handle behind bottom clip. See page 30.
2. Rotate top clip to secure (lock) handle.



To Install Pump Cover:

1. Position cover over module back cover. See Photo F.
2. Align outside cover lip with bottom cover offset and insert outside cover. See Photo G.

Align and insert bottom of cover.

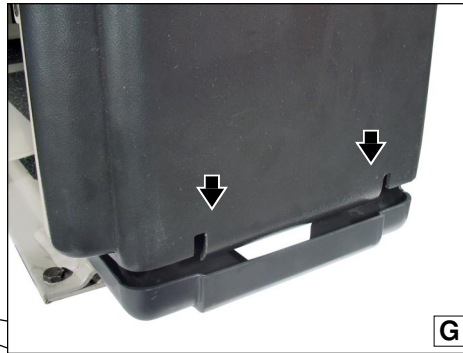

3. Insert wing stud and rotate 1/4 turn to lock cover. See Photo H.



Decals and Antiskid

⚠ WARNING

Replace missing, worn or illegible decals. Failure to do so may result in serious bodily injury and/or property damage.

Note: Clean surfaces with isopropyl alcohol before decal or antiskid application. Use a clean cloth or paper towels. **Do not** use oily shop rags. Wipe surface free of residue with dry portion of cleaning cloth.

See Decals on page 36 also.

Decals

The lift is only as safe as the operator. Replace any missing, worn or illegible decals! Part numbers are provided for decals. Inspect your lift for missing, worn or illegible decals. Call 1-800-THE LIFT for replacements.

25675

⚠ WARNING

Lift installation and servicing prohibited by anyone who has not been certified by The Braun Corporation Sales and Service School. Certified service technicians should call 1-800-THE LIFT to receive applicable installation/service manual. Failure to follow this policy may result in serious bodily injury and/or property damage.

25674

⚠ WARNING



Read manual before operating lift. Call 1-800-THE LIFT to receive operator's manual. Failure to do so may result in serious bodily injury and/or property damage. Keep manual in all pouch.

22249

⚠ WARNING

Contact The Braun Corporation before adjusting hydraulic pressure relief valve. Failure to do so may result in serious bodily injury and/or property damage.

27154

⚠ WARNING

Improper hydraulic pressure switch adjustment may result in serious bodily injury and/or property damage.

HYDRAULIC PRESSURE SWITCH ADJUSTMENT

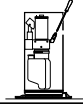

Adjust switch as specified in installation service manual.

28540

⚠ WARNING

- Read manual before operating lift.
- Load and unload on level surface only.
- Engage vehicle parking brake before operating lift.
- Provide adequate clearance outside of vehicle to accommodate lift.
- Do not operate lift if you suspect lift damage.
- Keep operator and bystanders clear unless lift is in operation.

Whenever a wheelchair passenger is on the platform, the platform bar must be latched.

- Passenger must be positioned fully inside yellow boundaries.
- Wheelchair brakes must be locked.
- Roll stops must be up.

Failure to follow these rules may result in serious bodily injury and/or property damage.

LIFT OPERATING INSTRUCTIONS

Note: Handrail belt must be engaged before use.

OPEN DOORS AND SECURE

TO UNLOAD PLATFORM:

Stand clear and press **UNFOLD** switch until platform stops (reaches floor level).

Note: In event platform does not unload, press **FOLD** switch to release LIFT™ rollers.

TO UNLOAD PASSENGER:

- Load passenger onto platform and lock wheelchair brakes.
- Press **DOWN** switch until entire platform reaches ground level and roll stop unfolds fully.
- Unlock handrail belt.
- Unlock wheelchair brakes and unload passenger from platform.

TO LOAD PASSENGER:

- Load passenger onto platform and lock wheelchair brakes.
- Latch handrail belt.
- Press **UP** switch to fold roll stop up and raise platform to floor level.
- Unlock wheelchair brakes and unload passenger from platform.

TO FOLD PLATFORM:

Press **FOLD** switch until platform stops. Release switch.

CLOSE DOORS:

- Level bottom of handrail.
- Roller bottom clip.

19342

OPERATING INSTRUCTIONS

Read warnings and operate lift as outlined on LIFT OPERATING INSTRUCTIONS decal. Lift operating instructions apply to wheelchair passengers and standees.

Standee Instructions: Standees must stand at center of platform (fully inside yellow boundaries), grip handrails and lower head to clear door jamb header.

Wheelchair Instructions: Lift instructions vary in type and operation. Interlock if equipped must be operated as instructed by transit authority.

29082

MANUAL OPERATION

TO REMOVE PUMP HANDLE:

- Release top clip.

Using hand pump handle:

- Insert handle in pump and rotate until platform reaches floor level.
- Insert handle in pump and rotate until platform reaches floor level. Open 1/2 turn only.
- Open hand pump valve (turn counterclockwise). Open 1/2 turn only.

DOWN TO LOWEST:

Open hand pump valve (turn counterclockwise). Open 1/2 turn only.

UP TO HIGHEST:

- Close hand pump valve (turn clockwise).
- Insert handle in pump and rotate until platform reaches floor level.

TO FOLD PLATFORM (PL):

Insert handle in pump and rotate.

Note: Close valve before operating electric pump.

TO STORE PUMP HANDLE:

- Level bottom of handle.
- Roller bottom clip.
- Roller top clip.

Decals and Antiskid



Note: Clean surfaces as detailed on opposite page before posting decals.

See Decals on page 35 also.

24369-12 (actual size: 1-1/2" x 11")



25217 (actual size: 5/8" x 23")



29093 (actual size: 5/16" x 23")



Decals

12375



18229



25652



29048



24668

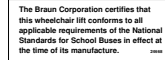

29052



29051

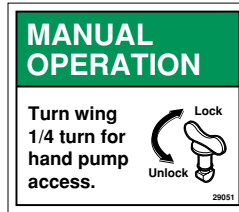

24242

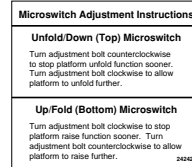

Decals and Antiskid



Antiskid

| Available Antiskid | | |
|--------------------|--------|-----------|
| Size | Color | Part No. |
| 2" x 12" | Black | #24172-BK |
| 2" x 12" | Yellow | #24172-YL |
| 3" x 12" | Black | #24173-BK |
| 3" x 12" | Yellow | #24173-YL |
| 6" x 12" | Black | #24174-BK |
| 6" x 12" | Yellow | #24174-YL |

Inspect your lift for any missing or worn antiskid. Order as needed.

Note: Clean surfaces with isopropyl alcohol before decal or antiskid application. Use a clean cloth or paper towels. **Do not** use oily shop rags. Wipe surface free of residue with dry portion of cleaning cloth.

Maintenance and Lubrication

Maintenance is necessary to ensure safe and trouble-free lift operation. General preventive maintenance consisting of inspections of your lift system and cleaning the lift should be a part of your routine.

The VL917IB has been designed with many self-lubricating components. Lubricate the pivot points specified on page 39 approximately every four weeks (or 400 cycles) with a light penetrating type oil (30 weight or equivalent). Severe conditions (weather, environment, heavy usage, etc.) may require more frequent lubrication.

Preventive maintenance visual inspections and lubrication procedures **do not** take the place

of the procedures specified in the Maintenance and Lubrication Schedule provided in the applicable lift installation and service manual. The procedures outlined in the Maintenance and Lubrication Schedule **must be performed at the recommended scheduled intervals by an authorized Braun Corporation service representative who has attended and been certified by The Braun Corporation Sales and Service School.**

If the scheduled maintenance and lubrication procedures are not being performed, or if there is any sign of lift damage, wear, abnormal condition or improper operation, **discontinue lift use immediately.** Contact your sales representative or call The Braun

Corporation at 1-800-THE LIFT. One of our national Product Support representatives will direct you to an authorized service technician who will inspect your lift.

WARNING

Maintenance and lubrication procedures must be performed by authorized service personnel as specified in the applicable installation/service manual. Failure to do so may result in serious bodily injury and/or property damage.

Maintenance and Lubrication

Note: LPS2 General Purpose Penetrating Oil is available in eleven ounce aerosol cans from The Braun Corporation (part number 15807).

Note: Clean lubrication points **before** applying lubricant.

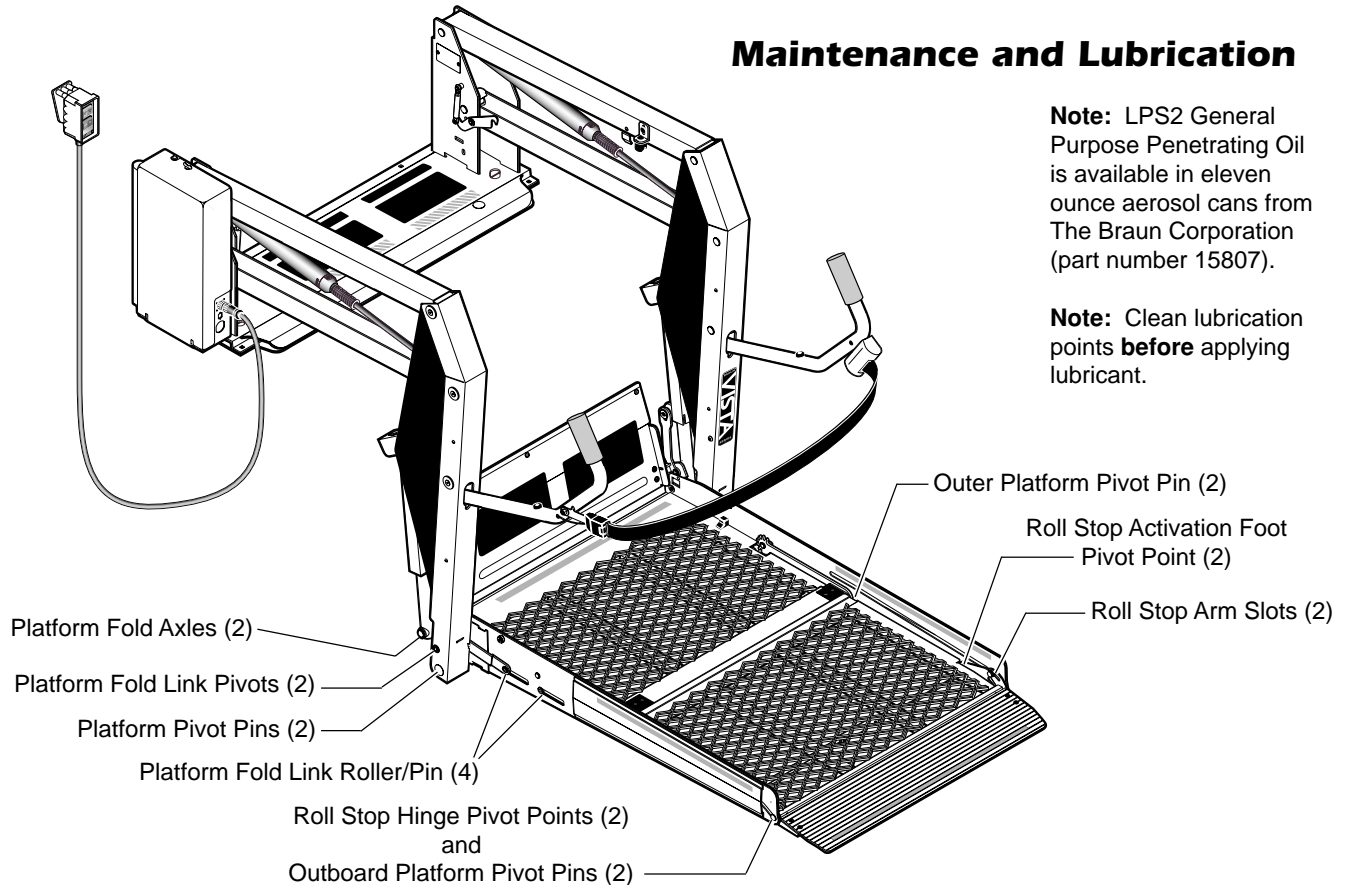

Warranty and Registration Instructions

Immediately upon receiving your lift, examine the unit for any damage. Notify the carrier at once with any claims.

Two warranty/registration cards (shown below) are located in the lift-mounted owner's manual storage pouch. The sales representative must process one of the

cards. The consumer must fill out the other card and mail it to The Braun Corporation. The warranty is provided on the back cover of this manual. The **warranty cards must be processed to activate the warranty.**

The Braun Serial No./Series No. identification tag (shown below) is

located on the opposite pump side tower. This I.D. tag contains the product identification information provided on the Warranty/Registration card. Record the information in the space provided on the next page. **This information must be provided when filing a warranty claim or ordering parts.**

Series No. Pump Code
Model No. Serial No. Cylinder Code

OWNER'S WARRANTY REGISTRATION
VL9171B-02-00179-37-14CG

PURCHASED FROM _____

OWNER _____

NAME _____ DATE INSTALLED _____

ADDRESS _____

CITY _____

TELEPHONE _____ STATE _____ ZIP _____

TO VALIDATE WARRANTY
REGISTRATION CARDS MUST BE RETURNED TO THE BRAUN CORPORATION.

Sample Warranty/Registration Card

The Braun Corporation
PO Box 310
Winamac, IN 46996
(574) 946-6153

LIFT MODEL #
VL9171B

SERIAL NUMBER
02-00179

PUMP CODE CYLINDER
37 14CG

MFG DATE
3/14/2003

PATENT PENDING-5,261,773-6,065,924-6,238,169

Sample Serial No./Series No. Identification Tag

Warranty and Registration Instructions

Model No. _____ Pump Code _____

Series No. _____ Cylinder Code _____

Serial No. _____ Date of Manufacture _____

Note: Retain this information for future use. You must have this information when filing a warranty claim or ordering

"Providing Access to the World"®

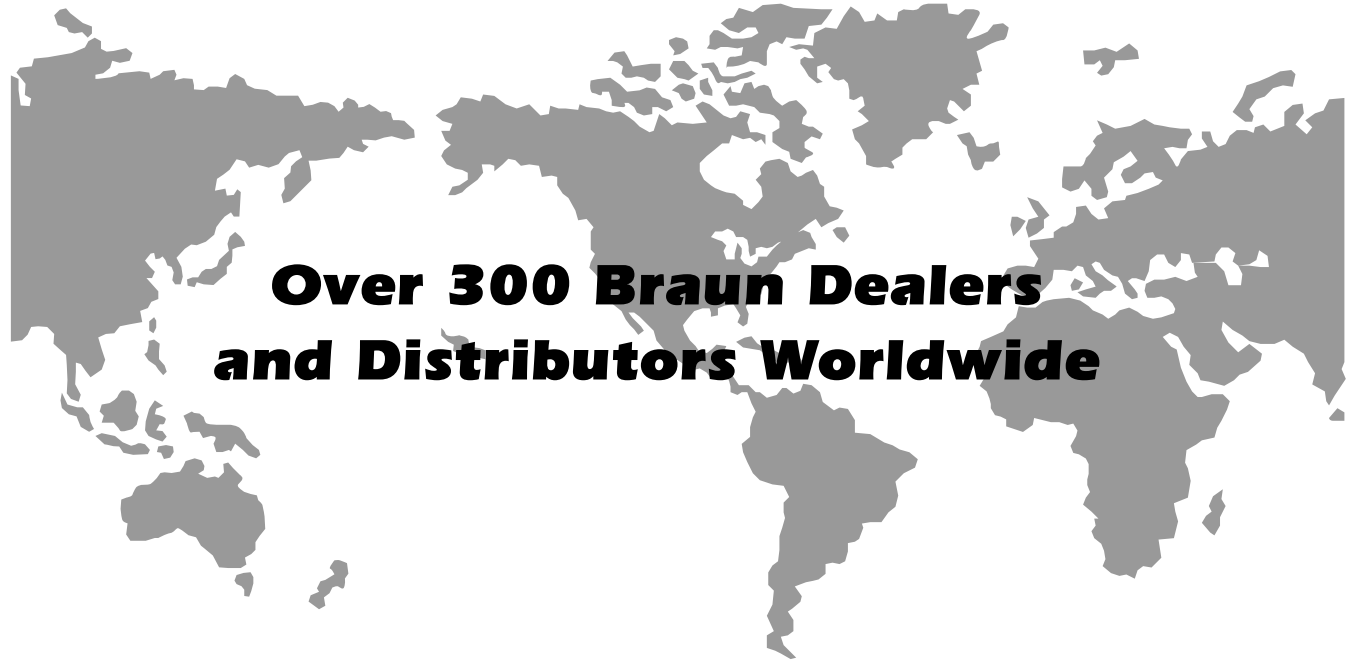

**Over 300 Braun Dealers
and Distributors Worldwide**



Braun Limited Warranty

Consult your local Braun dealer regarding warranty policy.

www.braunlift.com/international

complying with

ADA

**Americans With
Disabilities Act**

VL9171B

Series 02

Operator's Manual